



Quoted price _____

barbie kennedy

DESIGNS

Date _____

Classic Tooth Pattern

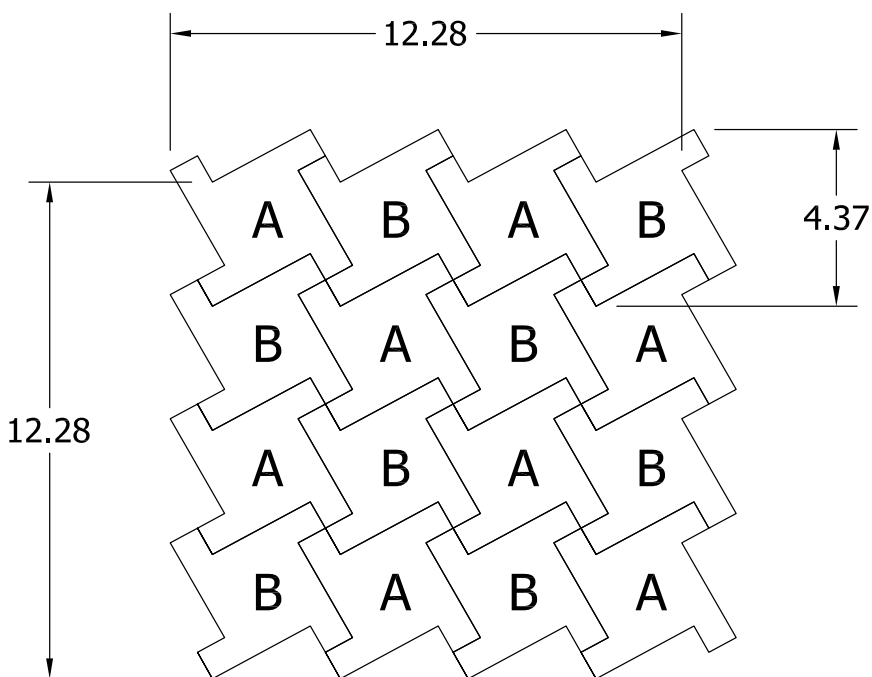

Unit A _____

Unit B _____

All designs are made to order and are not returnable. Please chose your colors carefully. Stone and wood materials have a myriad of characteristics. Variation in color and shade are inherent characteristics in these natural materials. Before setting, please verify colors and shade.

Made to measure dimensions are extremely important to ensure that your design fits perfectly into your space. Please take the proper care and steps when providing BKD your dimensions.

1.05 s/f per template

- My made to measure dimensions are _____
they are attached to this sheet with the layout of the room.

Clients Signature _____

Date _____

By signing this form I understand that this is a custom design and is not returnable. All materials are subject to have range and variation. I also understand that I am responsible for the made to measure dimensions and when I sign this agreement I am responsible for full payment of this design.

Mark Thee pattern 8

Classic Tooth Large Format

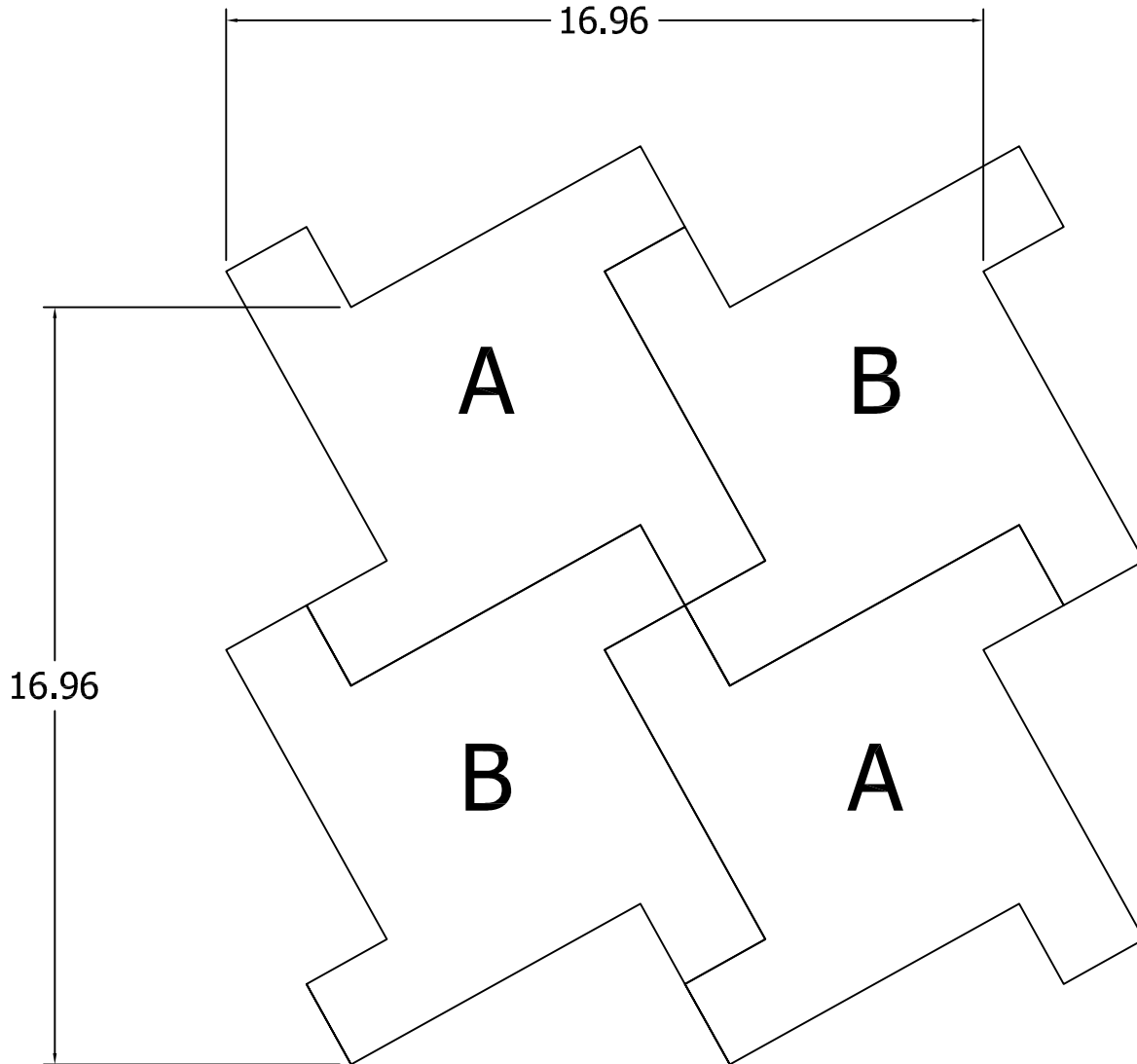

1 unit = 2.00 sq. ft.

Quoted price _____



barbie kennedy

Date _____

DESIGNS

Small Concentric Flow Pattern

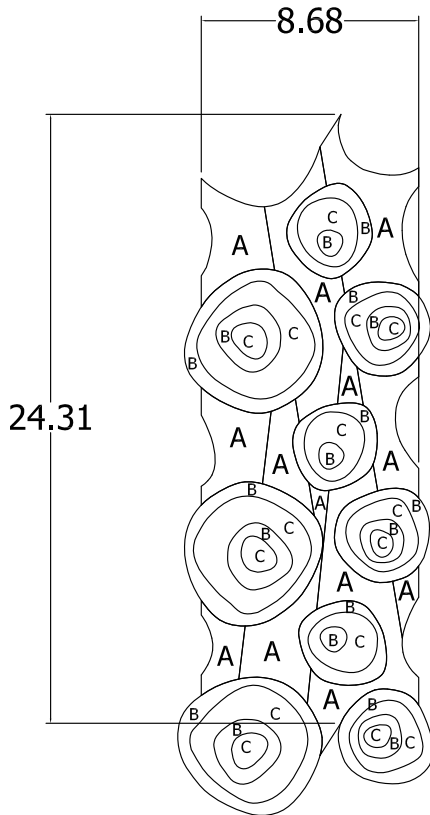

Unit A _____

Unit B _____

Unit C _____

All designs are made to order and are not returnable. Please chose your colors carefully. Stone and wood materials have a myriad of characteristics. Variation in color and shade are inherent characteristics in these natural materials. Before setting, please verify colors and shade.

Made to measure dimensions are extremely important to ensure that your design fits perfectly into your space. Please take the proper care and steps when providing BKD your dimensions.

1.46 s/f per template

- My made to measure dimensions are _____
they are attached to this sheet with the layout of the room.

Clients Signature

Date

By signing this form I understand that this is a custom design and is not returnable. All materials are subject to have range and variation. I also understand that I am responsible for the made to measure dimensions and when I sign this agreement I am responsible for full payment of this design.



Quoted price _____

barbie kennedy

DESIGNS

Date _____

Cubic Small Pattern

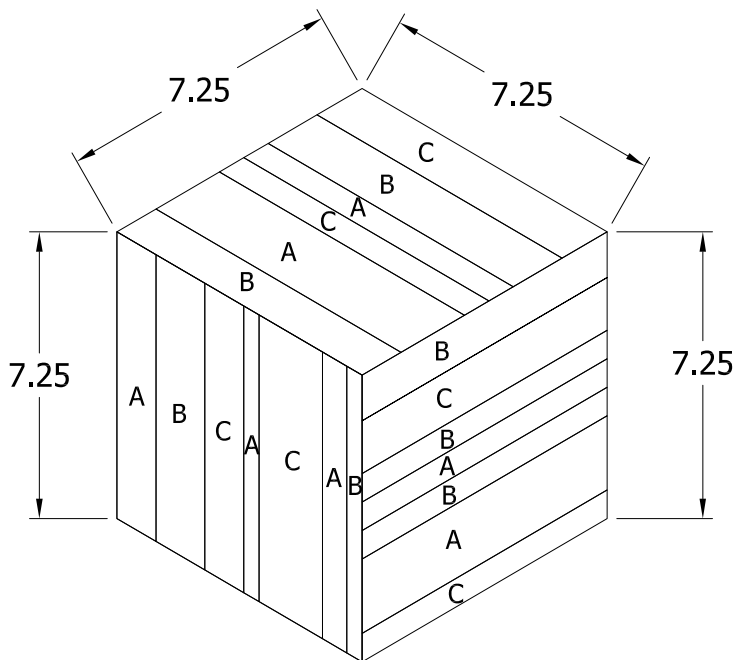

Unit A _____

Unit B _____

Unit C _____

All designs are made to order and are not returnable. Please chose your colors carefully. Stone and wood materials have a myriad of characteristics. Variation in color and shade are inherent characteristics in these natural materials. Before setting, please verify colors and shade.

Made to measure dimensions are extremely important to ensure that your design fits perfectly into your space. Please take the proper care and steps when providing BKD your dimensions.

.95 s/f per template

- My made to measure dimensions are _____
they are attached to this sheet with the layout of the room.

Clients Signature

Date

By signing this form I understand that this is a custom design and is not returnable. All materials are subject to have range and variation. I also understand that I am responsible for the made to measure dimensions and when I sign this agreement I am responsible for full payment of this design.



Quoted price _____

barbie kennedy

DESIGNS

Date _____

Feathers Pattern

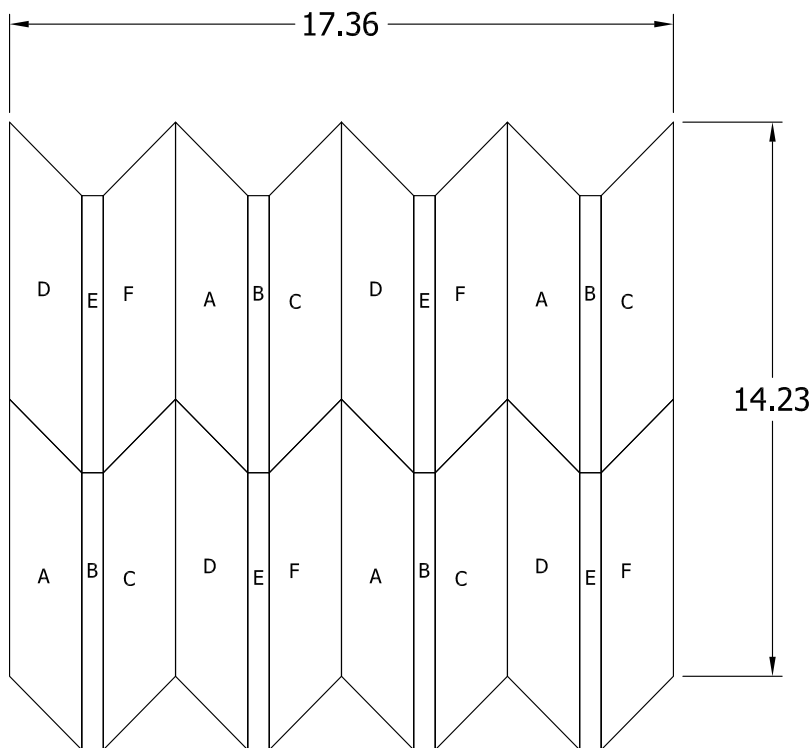

Unit A _____
Unit B _____
Unit C _____

All designs are made to order and are not returnable. Please chose your colors carefully. Stone and wood materials have a myriad of characteristics. Variation in color and shade are inherent characteristics in these natural materials. Before setting, please verify colors and shade.

Made to measure dimensions are extremely important to ensure that your design fits perfectly into your space. Please take the proper care and steps when providing BKD your dimensions.

1.72 s/f per template

- My made to measure dimensions are _____
- they are attached to this sheet with the layout of the room.

Clients Signature _____

Date _____

By signing this form I understand that this is a custom design and is not returnable. All materials are subject to have range and variation. I also understand that I am responsible for the made to measure dimensions and when I sign this agreement I am responsible for full payment of this design.



Quoted price _____

barbie kennedy

DESIGNS

Date _____

Hexing Small Pattern

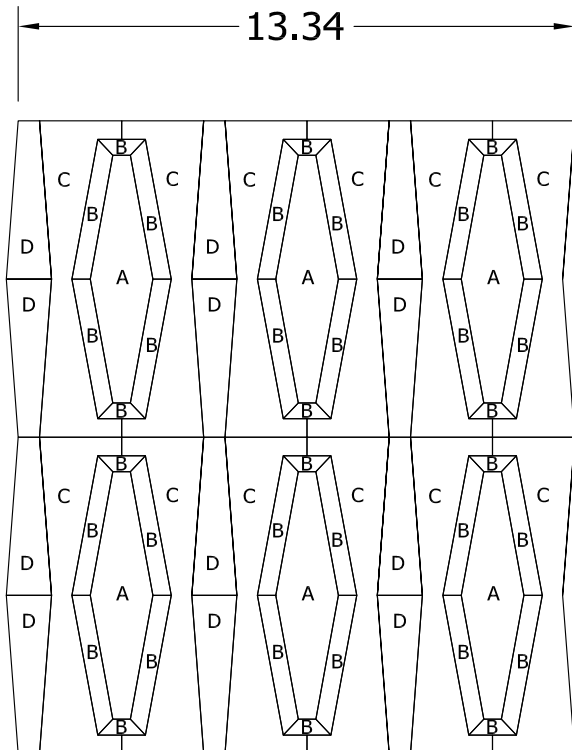

Unit A _____

Unit B _____

Unit C _____

Unit D _____

16.00

All designs are made to order and are not returnable. Please chose your colors carefully. Stone and wood materials have a myriad of characteristics. Variation in color and shade are inherent characteristics in these natural materials. Before setting, please verify colors and shade.

Made to measure dimensions are extremely important to ensure that your design fits perfectly into your space. Please take the proper care and steps when providing BKD your dimensions.

1.48 s/f per template

- My made to measure dimensions are _____
- they are attached to this sheet with the layout of the room.

Clients Signature

Date

By signing this form I understand that this is a custom design and is not returnable. All materials are subject to have range and variation. I also understand that I am responsible for the made to measure dimensions and when I sign this agreement I am responsible for full payment of this design.



Quoted price _____

Date _____

barbie kennedy

DESIGNS

Lina Wrap Pattern

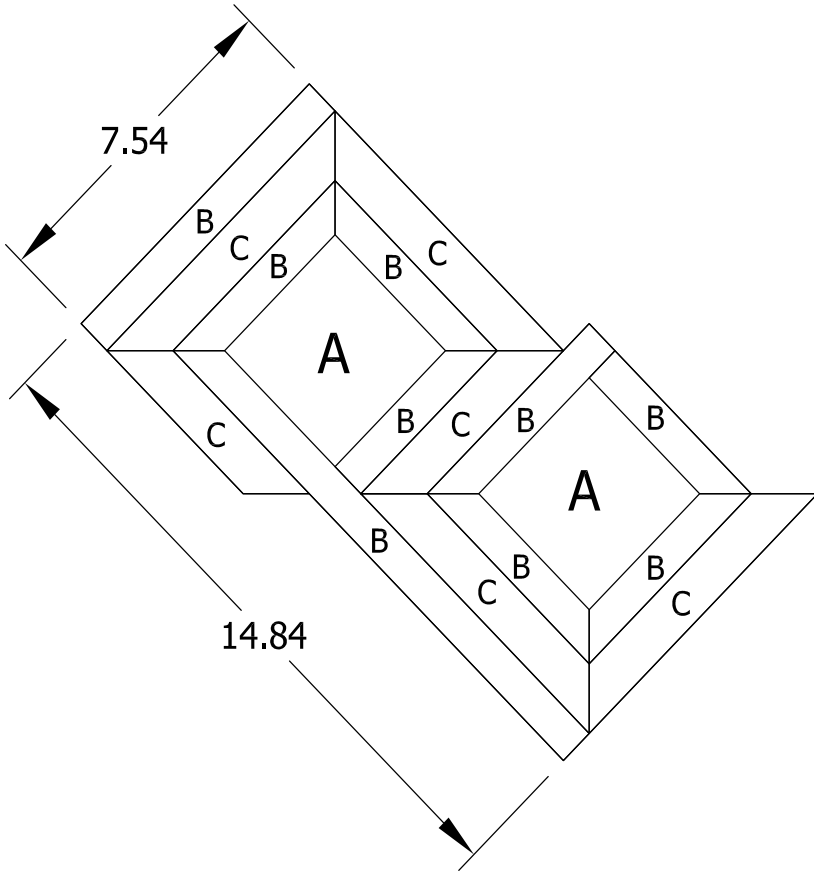

Unit A _____

Unit B _____

Unit C _____

All designs are made to order and are not returnable. Please chose your colors carefully. Stone and wood materials have a myriad of characteristics. Variation in color and shade are inherent characteristics in these natural materials. Before setting, please verify colors and shade.

Made to measure dimensions are extremely important to ensure that your design fits perfectly into your space. Please take the proper care and steps when providing BKD your dimensions.

.75 s/f per template

- My made to measure dimensions are _____
- they are attached to this sheet with the layout of the room.

Clients Signature

Date

By signing this form I understand that this is a custom design and is not returnable. All materials are subject to have range and variation. I also understand that I am responsible for the made to measure dimensions and when I sign this agreement I am responsible for full payment of this design.

Lina Wrap
Large Format

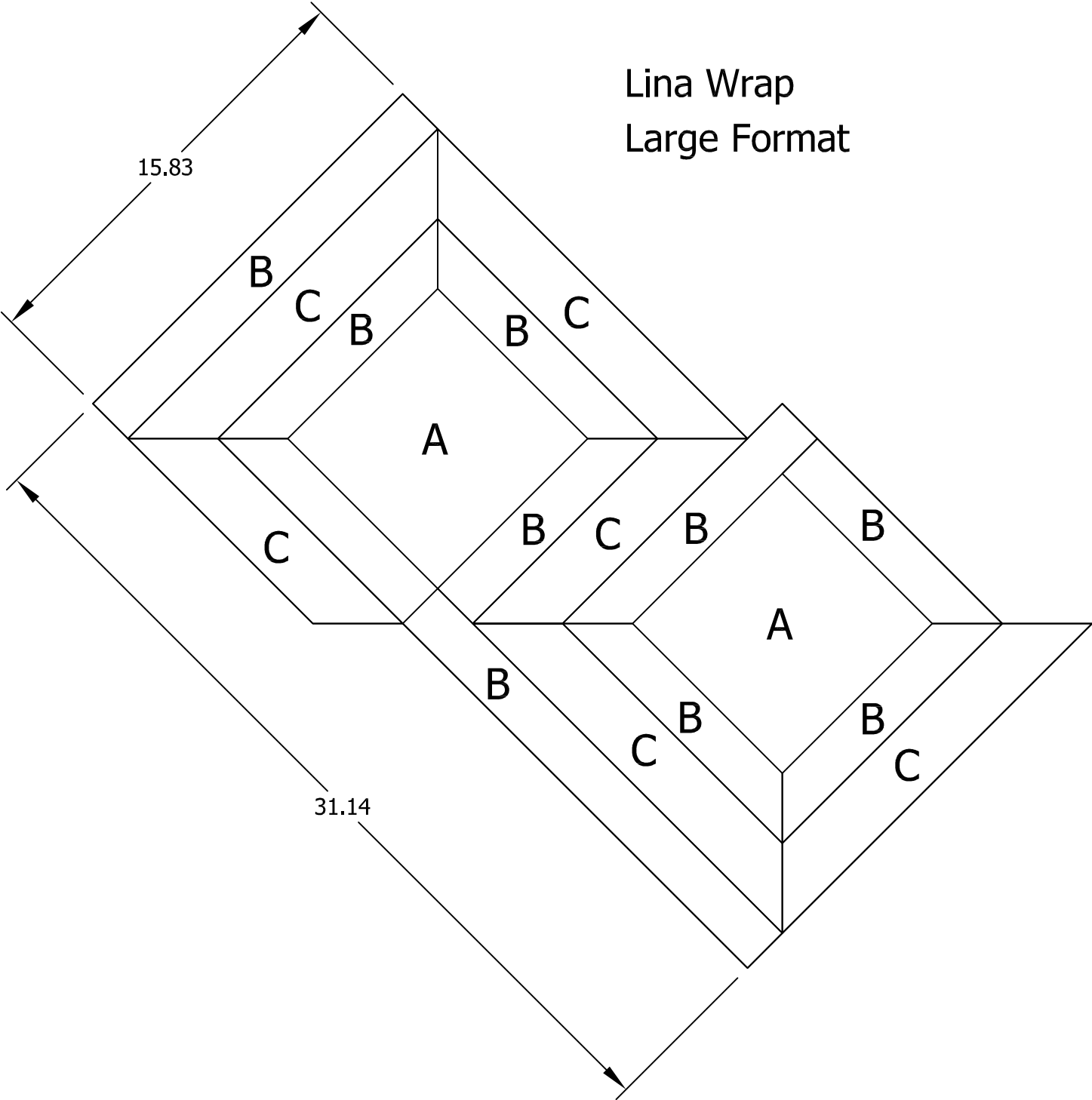

1 unit = 3.31 sq. ft.



Quoted price _____

barbie kennedy

DESIGNS

Date _____

Modern Overlay Pattern

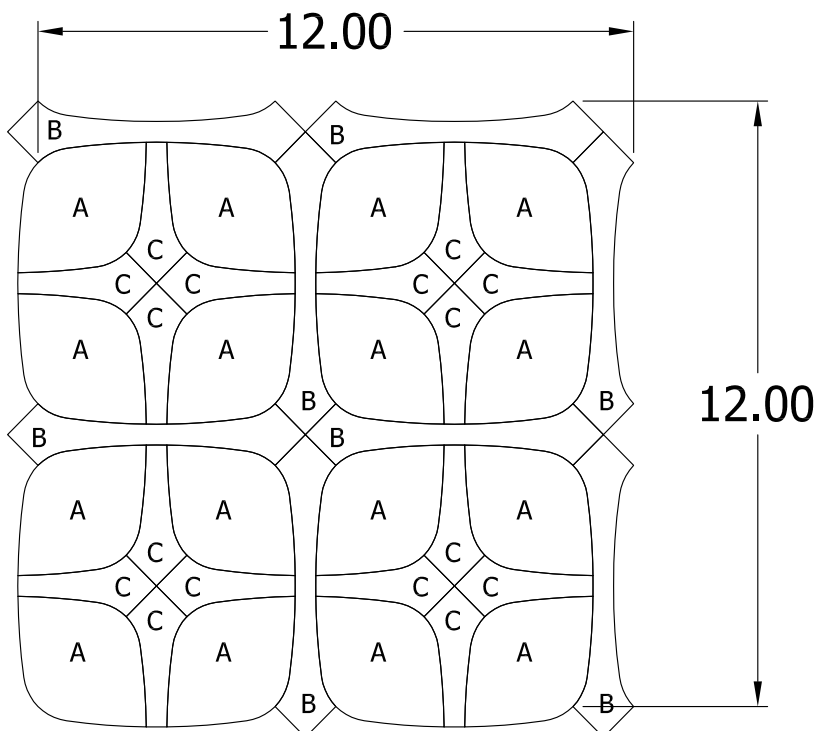

Unit A _____

Unit B _____

Unit C _____

All designs are made to order and are not returnable. Please chose your colors carefully. Stone and wood materials have a myriad of characteristics. Variation in color and shade are inherent characteristics in these natural materials. Before setting, please verify colors and shade.

Made to measure dimensions are extremely important to ensure that your design fits perfectly into your space. Please take the proper care and steps when providing BKD your dimensions.

1 s/f per template

- My made to measure dimensions are _____
- they are attached to this sheet with the layout of the room.

Clients Signature

Date

By signing this form I understand that this is a custom design and is not returnable. All materials are subject to have range and variation. I also understand that I am responsible for the made to measure dimensions and when I sign this agreement I am responsible for full payment of this design.



Quoted price _____

barbie kennedy

DESIGNS

Date _____

Modern Overlay Large Pattern

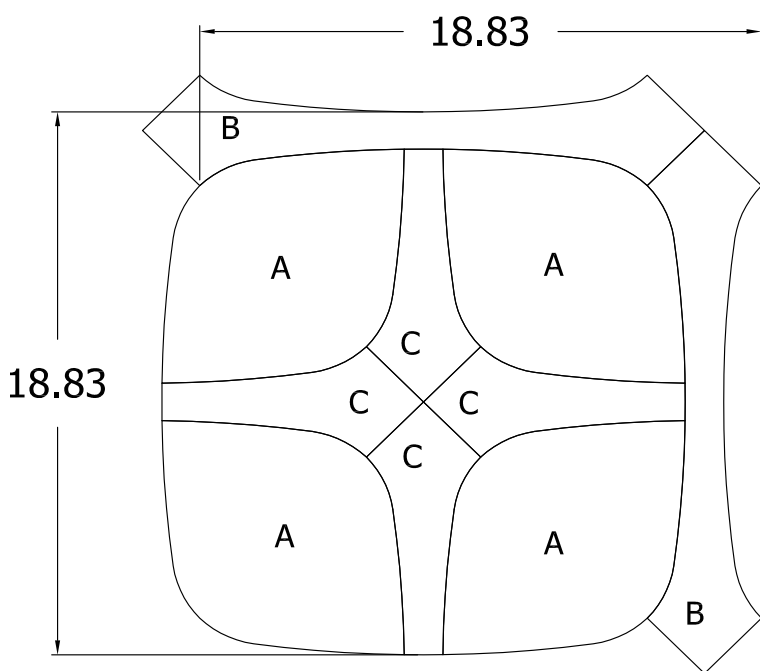

Unit A _____

Unit B _____

Unit C _____

All designs are made to order and are not returnable. Please chose your colors carefully. Stone and wood materials have a myriad of characteristics. Variation in color and shade are inherent characteristics in these natural materials. Before setting, please verify colors and shade.

Made to measure dimensions are extremely important to ensure that your design fits perfectly into your space. Please take the proper care and steps when providing BKD your dimensions.

2.46 s/f per template

- My made to measure dimensions are _____
they are attached to this sheet with the layout of the room.

Clients Signature

Date

By signing this form I understand that this is a custom design and is not returnable. All materials are subject to have range and variation. I also understand that I am responsible for the made to measure dimensions and when I sign this agreement I am responsible for full payment of this design.



Quoted price _____

barbie kennedy

Date _____

DESIGNS

Perma Link Pattern

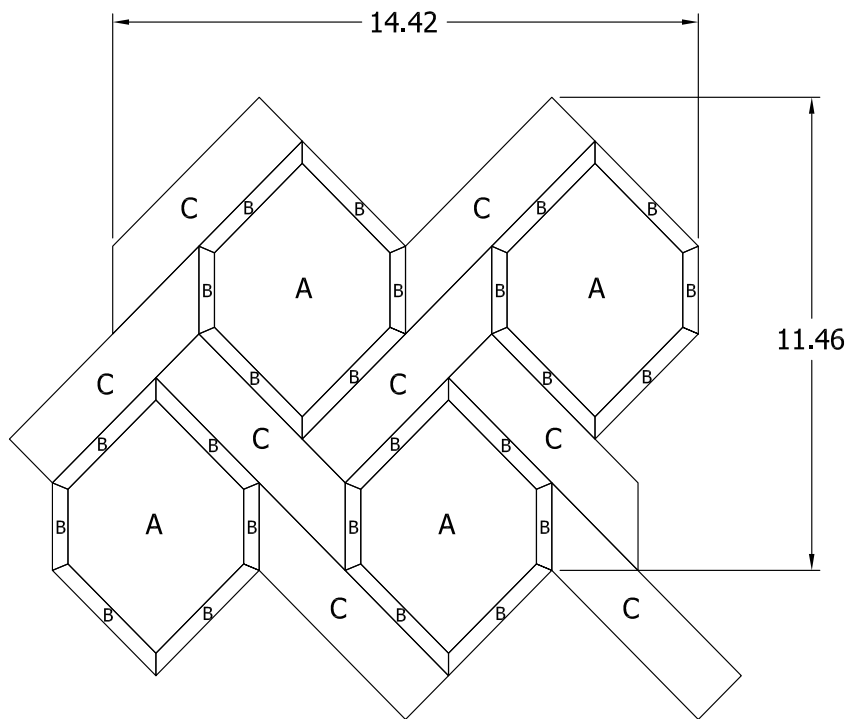

Unit A _____

Unit B _____

Unit C _____

All designs are made to order and are not returnable. Please chose your colors carefully. Stone and wood materials have a myriad of characteristics. Variation in color and shade are inherent characteristics in these natural materials. Before setting, please verify colors and shade.

Made to measure dimensions are extremely important to ensure that your design fits perfectly into your space. Please take the proper care and steps when providing BKD your dimensions.

1.15 s/f per template

- My made to measure dimensions are _____
they are attached to this sheet with the layout of the room.

Clients Signature

Date

By signing this form I understand that this is a custom design and is not returnable. All materials are subject to have range and variation. I also understand that I am responsible for the made to measure dimensions and when I sign this agreement I am responsible for full payment of this design.



Quoted price _____

Date _____

barbie kennedy

DESIGNS

Perma Link Large Pattern

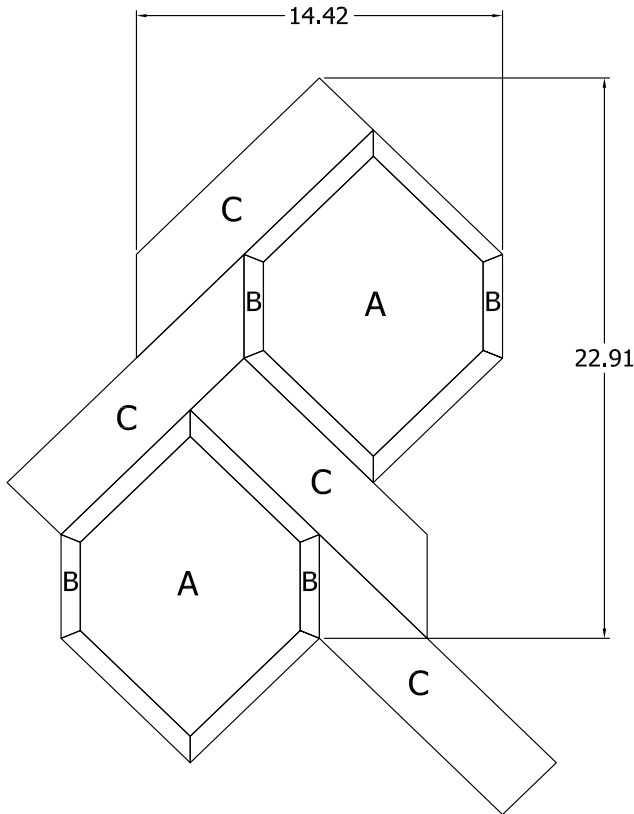

Unit A _____

Unit B _____

Unit C _____

All designs are made to order and are not returnable. Please chose your colors carefully. Stone and wood materials have a myriad of characteristics. Variation in color and shade are inherent characteristics in these natural materials. Before setting, please verify colors and shade.

Made to measure dimensions are extremely important to ensure that your design fits perfectly into your space. Please take the proper care and steps when providing BKD your dimensions.

2.29 s/f per template

- My made to measure dimensions are _____
- they are attached to this sheet with the layout of the room.

Clients Signature

Date

By signing this form I understand that this is a custom design and is not returnable. All materials are subject to have range and variation. I also understand that I am responsible for the made to measure dimensions and when I sign this agreement I am responsible for full payment of this design.



Quoted price _____

barbie kennedy

DESIGNS

Date _____

Wedge Small Pattern

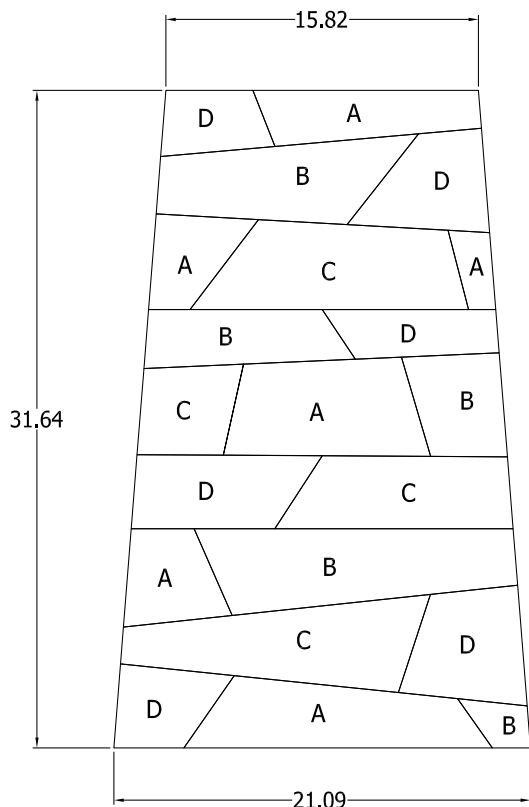

Unit A _____

Unit B _____

Unit C _____

Unit D _____

All designs are made to order and are not returnable. Please chose your colors carefully. Stone and wood materials have a myriad of characteristics. Variation in color and shade are inherent characteristics in these natural materials. Before setting, please verify colors and shade.

Made to measure dimensions are extremely important to ensure that your design fits perfectly into your space. Please take the proper care and steps when providing BKD your dimensions.

4.06 s/f per template

- My made to measure dimensions are _____
- they are attached to this sheet with the layout of the room.

Clients Signature

Date

By signing this form I understand that this is a custom design and is not returnable. All materials are subject to have range and variation. I also understand that I am responsible for the made to measure dimensions and when I sign this agreement I am responsible for full payment of this design.

Wedge Pattern Large Format Marc Thee # 2

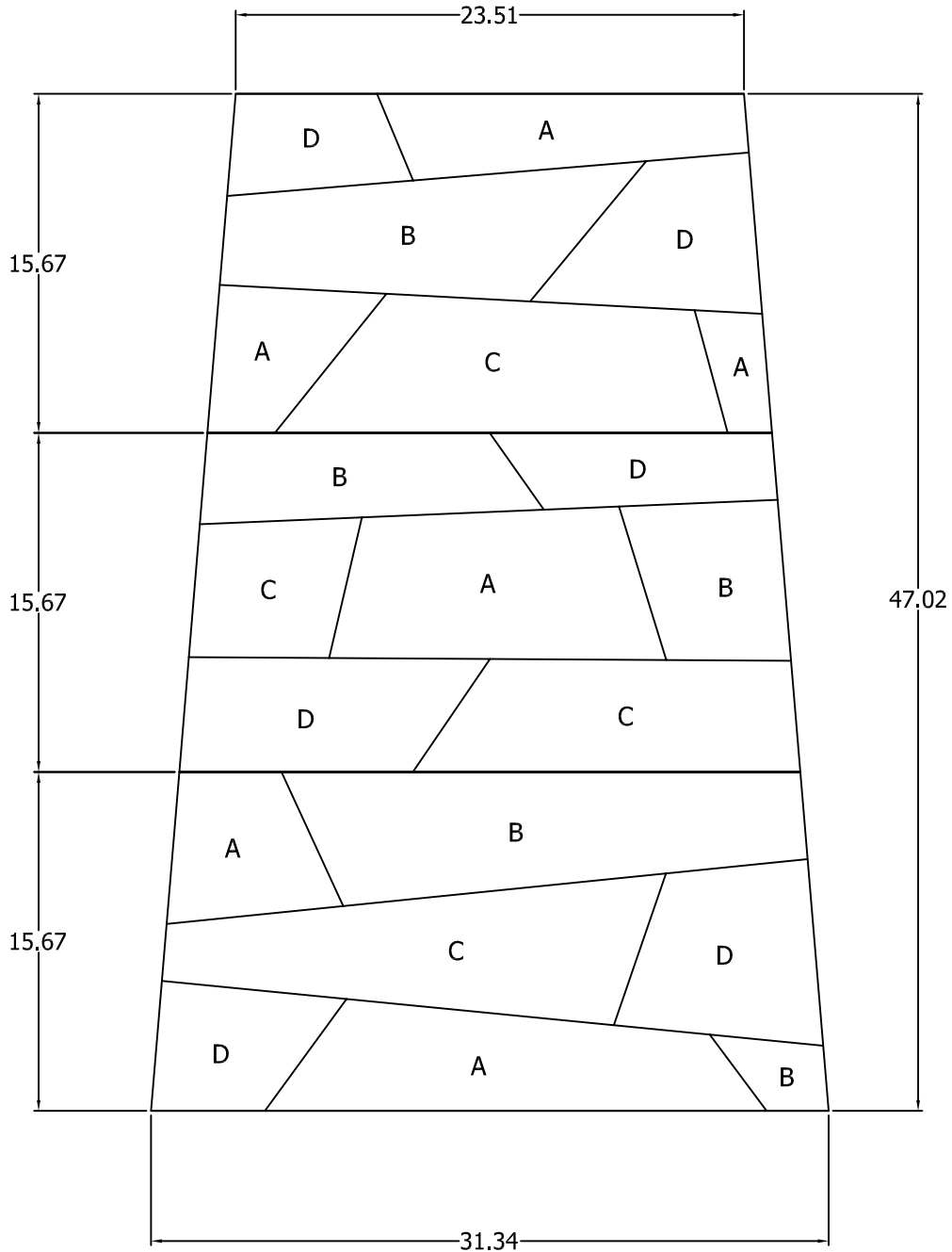

1 unit (3 sections) = 8.95 sq. ft.



Quoted price _____

Date _____

barbie kennedy

DESIGNS

Wind and Wave Large Pattern

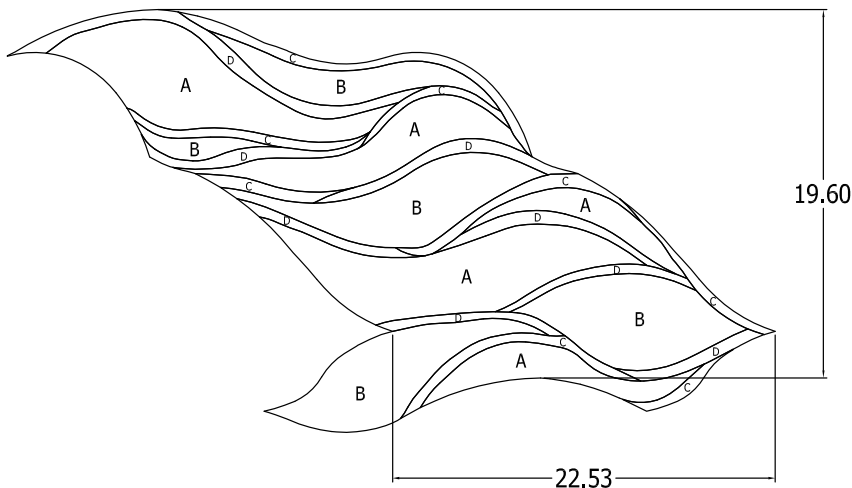

Unit A _____

Unit B _____

Unit C _____

Unit D _____

All designs are made to order and are not returnable. Please chose your colors carefully. Stone and wood materials have a myriad of characteristics. Variation in color and shade are inherent characteristics in these natural materials. Before setting, please verify colors and shade.

Made to measure dimensions are extremely important to ensure that your design fits perfectly into your space. Please take the proper care and steps when providing BKD your dimensions.

3.066 s/f per template

- My made to measure dimensions are _____
- they are attached to this sheet with the layout of the room.

Clients Signature

Date

By signing this form I understand that this is a custom design and is not returnable. All materials are subject to have range and variation. I also understand that I am responsible for the made to measure dimensions and when I sign this agreement I am responsible for full payment of this design.