



Quoted price _____

barbie kennedy

DESIGNS

Date _____

Bridget Pattern

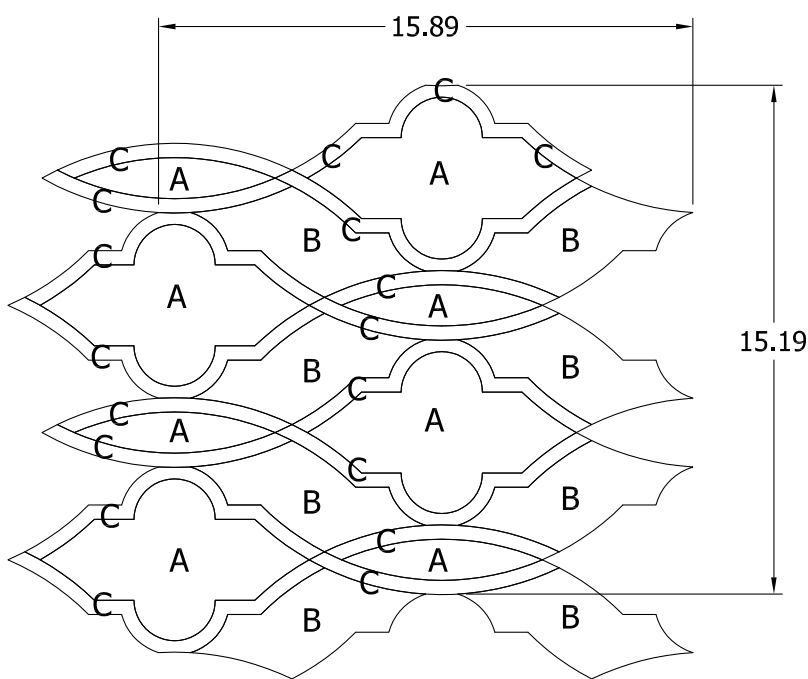

Unit A _____

Unit B _____

Unit C _____

All designs are made to order and are not returnable. Please chose your colors carefully. Stone and wood materials have a myriad of characteristics. Variation in color and shade are inherent characteristics in these natural materials. Before setting, please verify colors and shade.

Made to measure dimensions are extremely important to ensure that your design fits perfectly into your space. Please take the proper care and steps when providing BKD your dimensions.

1.68 s/f per template

- My made to measure dimensions are _____
- they are attached to this sheet with the layout of the room.

Clients Signature

Date

By signing this form I understand that this is a custom design and is not returnable. All materials are subject to have range and variation. I also understand that I am responsible for the made to measure dimensions and when I sign this agreement I am responsible for full payment of this design.



Quoted price _____

barbie kennedy

Date _____

DESIGNS

Delia Pattern

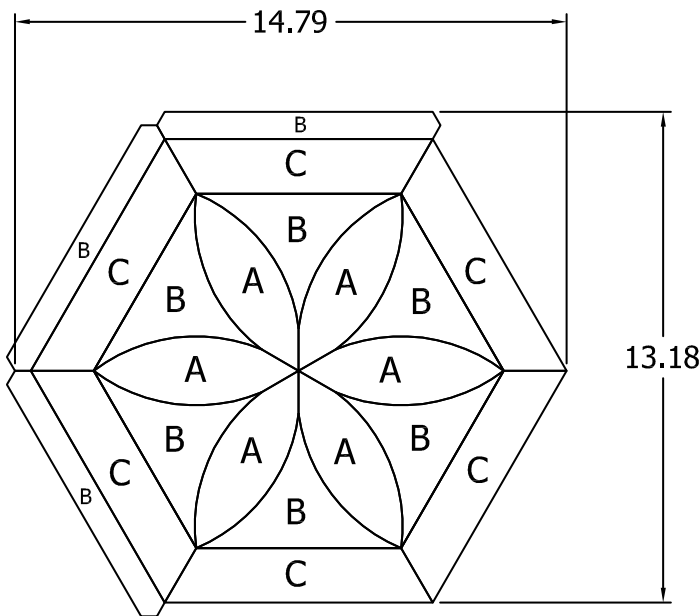

Unit A _____

Unit B _____

Unit C _____

All designs are made to order and are not returnable. Please chose your colors carefully. Stone and wood materials have a myriad of characteristics. Variation in color and shade are inherent characteristics in these natural materials. Before setting, please verify colors and shade.

Made to measure dimensions are extremely important to ensure that your design fits perfectly into your space. Please take the proper care and steps when providing BKD your dimensions.

1.04 s/f per template

- My made to measure dimensions are _____
they are attached to this sheet with the layout of the room.

Clients Signature

Date

By signing this form I understand that this is a custom design and is not returnable. All materials are subject to have range and variation. I also understand that I am responsible for the made to measure dimensions and when I sign this agreement I am responsible for full payment of this design.



Quoted price _____

barbie kennedy

DESIGNS

Date _____

Dennelly Pattern

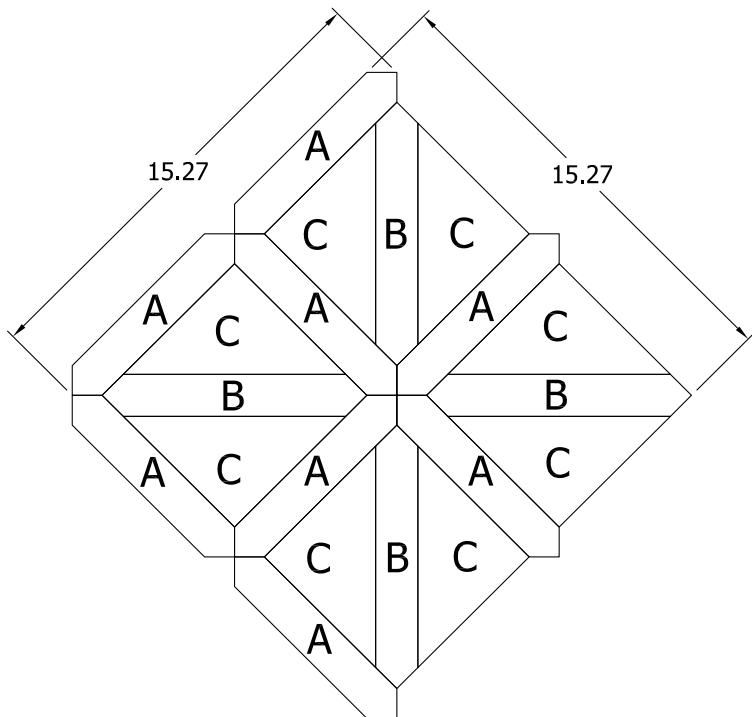

Unit A _____

Unit B _____

Unit C _____

All designs are made to order and are not returnable. Please chose your colors carefully. Stone and wood materials have a myriad of characteristics. Variation in color and shade are inherent characteristics in these natural materials. Before setting, please verify colors and shade.

Made to measure dimensions are extremely important to ensure that your design fits perfectly into your space. Please take the proper care and steps when providing BKD your dimensions.

1.62 s/f per template

- My made to measure dimensions are _____
- they are attached to this sheet with the layout of the room.

Clients Signature

Date

By signing this form I understand that this is a custom design and is not returnable. All materials are subject to have range and variation. I also understand that I am responsible for the made to measure dimensions and when I sign this agreement I am responsible for full payment of this design.



Quoted price

barbie kennedy

DESIGNS

Date

Edwin Pattern

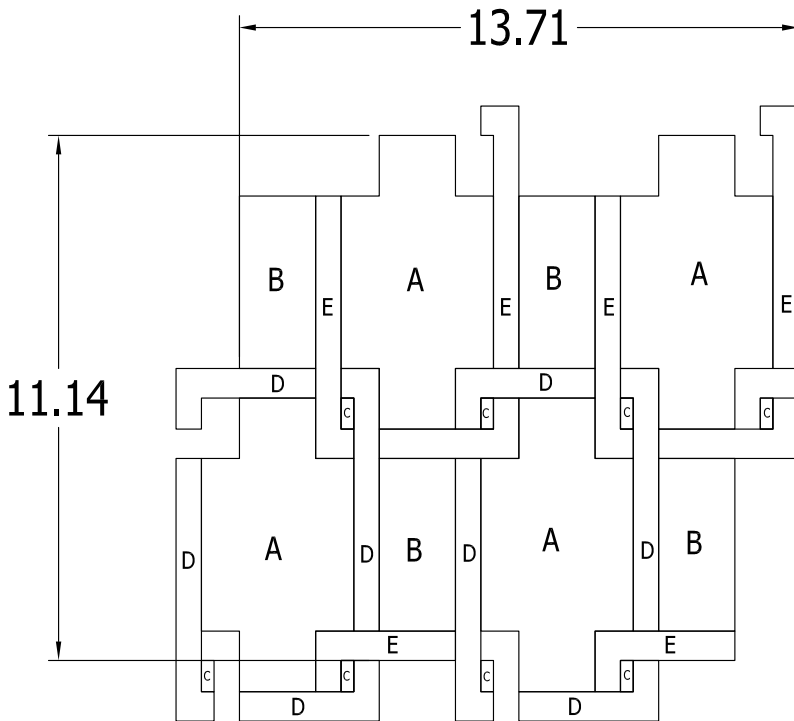

Unit A _____

Unit B _____

Unit C _____

Unit D _____

Unit E _____

All designs are made to order and are not returnable. Please chose your colors carefully. Stone and wood materials have a myriad of characteristics. Variation in color and shade are inherent characteristics in these natural materials. Before setting, please verify colors and shade.

Made to measure dimensions are extremely important to ensure that your design fits perfectly into your space. Please take the proper care and steps when providing BKD your dimensions.

1.06 s/f per template

- My made to measure dimensions are _____
- they are attached to this sheet with the layout of the room.

Clients Signature

Date

By signing this form I understand that this is a custom design and is not returnable. All materials are subject to have range and variation. I also understand that I am responsible for the made to measure dimensions and when I sign this agreement I am responsible for full payment of this design.



Quoted price _____

barbie kennedy

DESIGNS

Date _____

Ellen Pattern

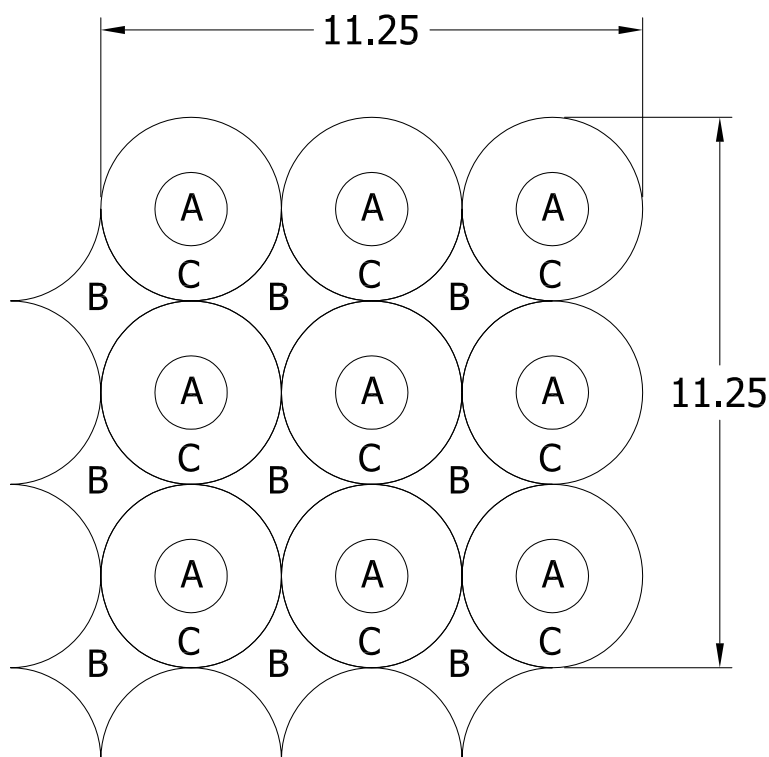

Unit A _____

Unit B _____

Unit C _____

All designs are made to order and are not returnable. Please chose your colors carefully. Stone and wood materials have a myriad of characteristics. Variation in color and shade are inherent characteristics in these natural materials. Before setting, please verify colors and shade.

Made to measure dimensions are extremely important to ensure that your design fits perfectly into your space. Please take the proper care and steps when providing BKD your dimensions.

.88 s/f per template

- My made to measure dimensions are _____
- they are attached to this sheet with the layout of the room.

Clients Signature

Date

By signing this form I understand that this is a custom design and is not returnable. All materials are subject to have range and variation. I also understand that I am responsible for the made to measure dimensions and when I sign this agreement I am responsible for full payment of this design.



Quoted price _____

barbie kennedy

DESIGNS

Date _____

Kennedy Pattern

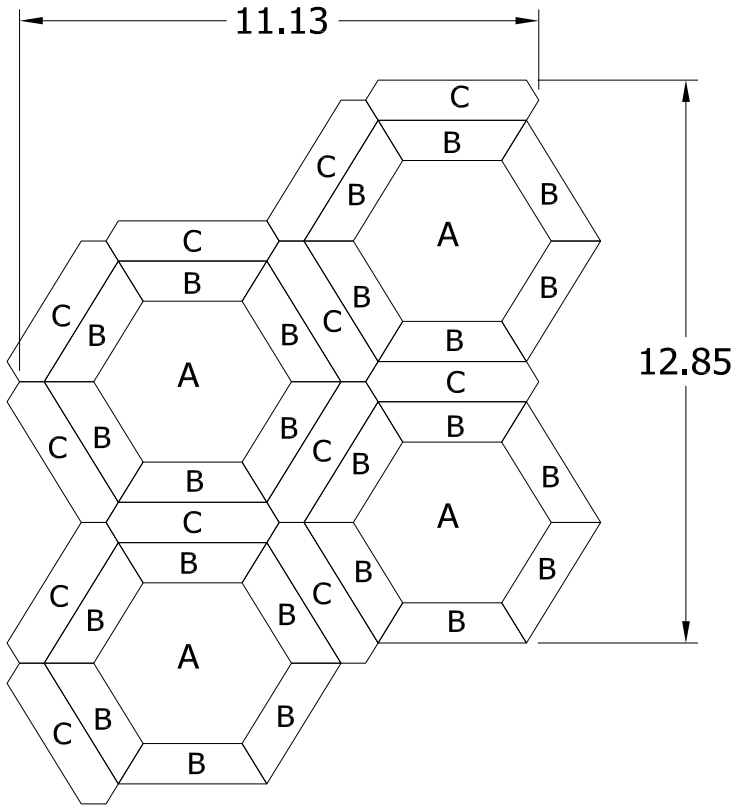

Unit A _____

Unit B _____

Unit C _____

All designs are made to order and are not returnable. Please chose your colors carefully. Stone and wood materials have a myriad of characteristics. Variation in color and shade are inherent characteristics in these natural materials. Before setting, please verify colors and shade.

Made to measure dimensions are extremely important to ensure that your design fits perfectly into your space. Please take the proper care and steps when providing BKD your dimensions.

1 s/f per template

- My made to measure dimensions are _____
- they are attached to this sheet with the layout of the room.

Clients Signature

Date

By signing this form I understand that this is a custom design and is not returnable. All materials are subject to have range and variation. I also understand that I am responsible for the made to measure dimensions and when I sign this agreement I am responsible for full payment of this design.



Quoted price _____

barbie kennedy

DESIGNS

Date _____

Maloney Pattern

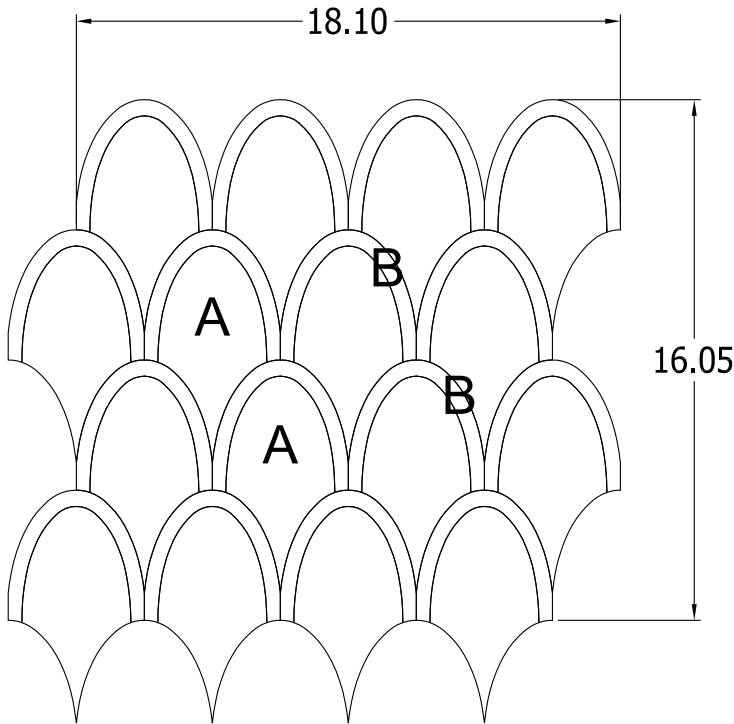

Unit A _____

Unit B _____

All designs are made to order and are not returnable. Please chose your colors carefully. Stone and wood materials have a myriad of characteristics. Variation in color and shade are inherent characteristics in these natural materials. Before setting, please verify colors and shade.

Made to measure dimensions are extremely important to ensure that your design fits perfectly into your space. Please take the proper care and steps when providing BKD your dimensions.

2.02 per template

- My made to measure dimensions are _____
- they are attached to this sheet with the layout of the room.

Clients Signature

Date

By signing this form I understand that this is a custom design and is not returnable. All materials are subject to have range and variation. I also understand that I am responsible for the made to measure dimensions and when I sign this agreement I am responsible for full payment of this design.



Quoted price _____

barbie kennedy

Date _____

DESIGNS

Margaret Pattern

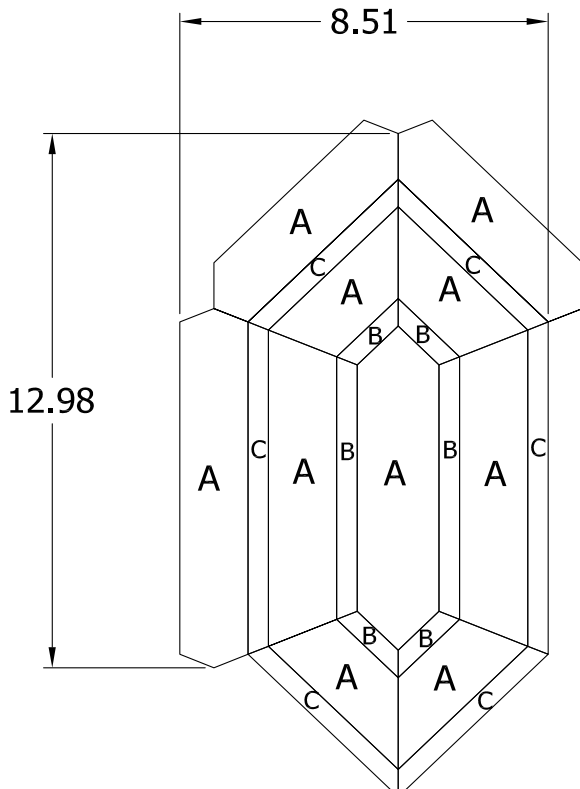

Unit A _____

Unit B _____

Unit C _____

All designs are made to order and are not returnable. Please chose your colors carefully. Stone and wood materials have a myriad of characteristics. Variation in color and shade are inherent characteristics in these natural materials. Before setting, please verify colors and shade.

Made to measure dimensions are extremely important to ensure that your design fits perfectly into your space. Please take the proper care and steps when providing BKD your dimensions.

.77 s/f per template

- My made to measure dimensions are _____
they are attached to this sheet with the layout of the room.

Clients Signature

Date

By signing this form I understand that this is a custom design and is not returnable. All materials are subject to have range and variation. I also understand that I am responsible for the made to measure dimensions and when I sign this agreement I am responsible for full payment of this design.



Quoted price _____

barbie kennedy

DESIGNS

Date _____

Newell Pattern

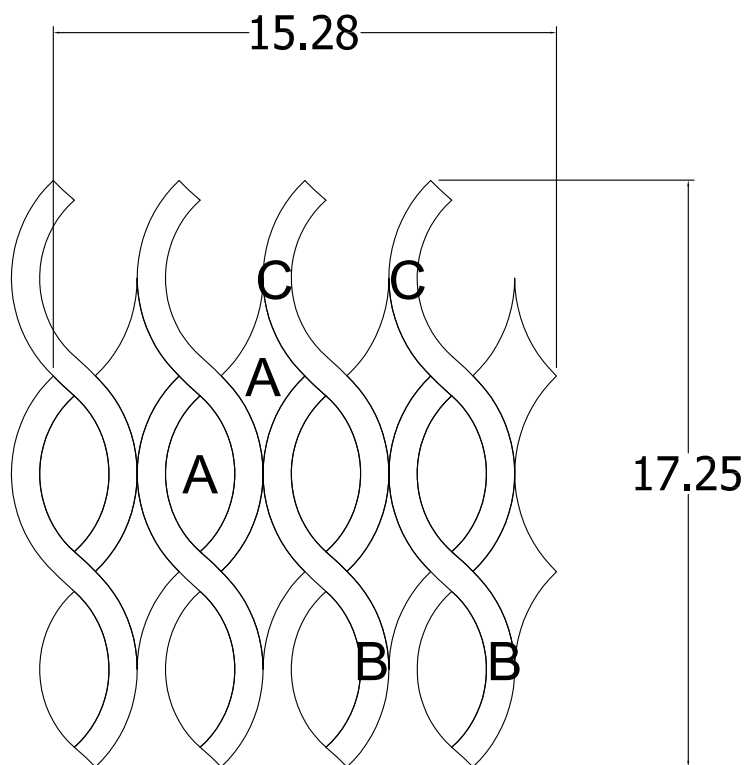

Unit A _____

Unit B _____

Unit C _____

All designs are made to order and are not returnable. Please chose your colors carefully. Stone and wood materials have a myriad of characteristics. Variation in color and shade are inherent characteristics in these natural materials. Before setting, please verify colors and shade.

Made to measure dimensions are extremely important to ensure that your design fits perfectly into your space. Please take the proper care and steps when providing BKD your dimensions.

1.22 per template

- My made to measure dimensions are _____
- they are attached to this sheet with the layout of the room.

Clients Signature

Date

By signing this form I understand that this is a custom design and is not returnable. All materials are subject to have range and variation. I also understand that I am responsible for the made to measure dimensions and when I sign this agreement I am responsible for full payment of this design.



Quoted price _____

barbie kennedy

DESIGNS

Date _____

Nickerson Pattern

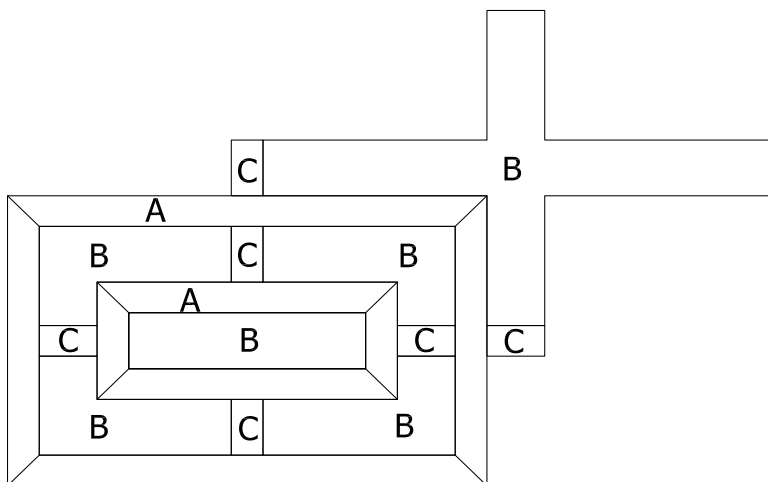

Unit A _____

Unit B _____

Unit C _____

All designs are made to order and are not returnable. Please chose your colors carefully. Stone and wood materials have a myriad of characteristics. Variation in color and shade are inherent characteristics in these natural materials. Before setting, please verify colors and shade.

Made to measure dimensions are extremely important to ensure that your design fits perfectly into your space. Please take the proper care and steps when providing BKD your dimensions.

.69 s/f per template

- My made to measure dimensions are _____
they are attached to this sheet with the layout of the room.

Clients Signature

Date

By signing this form I understand that this is a custom design and is not returnable. All materials are subject to have range and variation. I also understand that I am responsible for the made to measure dimensions and when I sign this agreement I am responsible for full payment of this design.



Quoted price

barbie kennedy

DESIGNS

Date

Richard Pattern

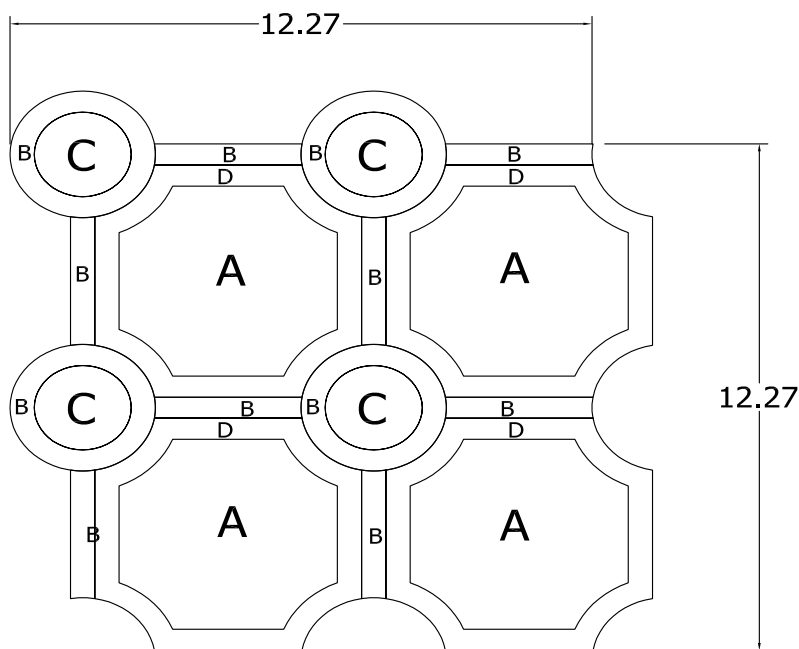

Unit A _____

Unit B _____

Unit C _____

Unit D _____

All designs are made to order and are not returnable. Please chose your colors carefully. Stone and wood materials have a myriad of characteristics. Variation in color and shade are inherent characteristics in these natural materials. Before setting, please verify colors and shade.

Made to measure dimensions are extremely important to ensure that your design fits perfectly into your space. Please take the proper care and steps when providing BKD your dimensions.

1.05 per template

- My made to measure dimensions are _____
- they are attached to this sheet with the layout of the room.

Clients Signature

Date

By signing this form I understand that this is a custom design and is not returnable. All materials are subject to have range and variation. I also understand that I am responsible for the made to measure dimensions and when I sign this agreement I am responsible for full payment of this design.



Quoted price _____

barbie kennedy

DESIGNS

Date _____

Samuel Pattern

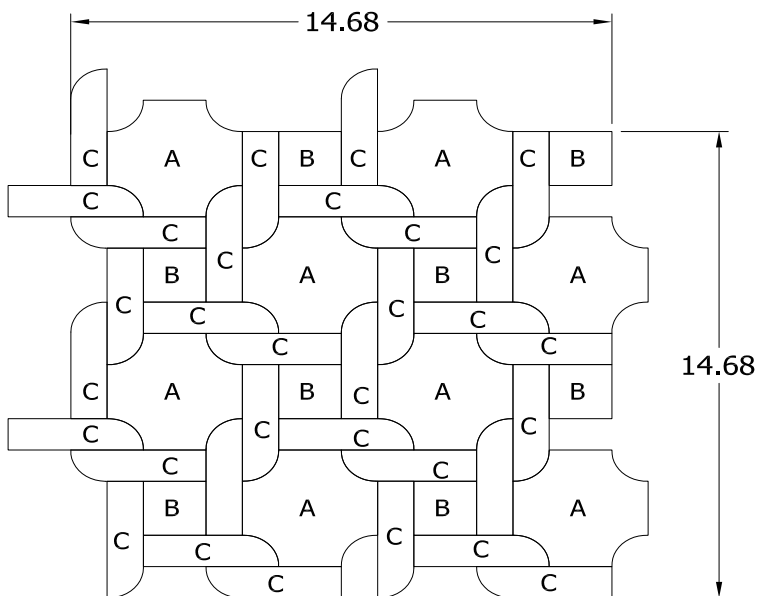

Unit A _____

Unit B _____

Unit C _____

All designs are made to order and are not returnable. Please chose your colors carefully. Stone and wood materials have a myriad of characteristics. Variation in color and shade are inherent characteristics in these natural materials. Before setting, please verify colors and shade.

Made to measure dimensions are extremely important to ensure that your design fits perfectly into your space. Please take the proper care and steps when providing BKD your dimensions.

1.50 s/f per template

- My made to measure dimensions are _____
- they are attached to this sheet with the layout of the room.

Clients Signature

Date

By signing this form I understand that this is a custom design and is not returnable. All materials are subject to have range and variation. I also understand that I am responsible for the made to measure dimensions and when I sign this agreement I am responsible for full payment of this design.



Quoted price _____

barbie kennedy

DESIGNS

Date _____

Watson Pattern

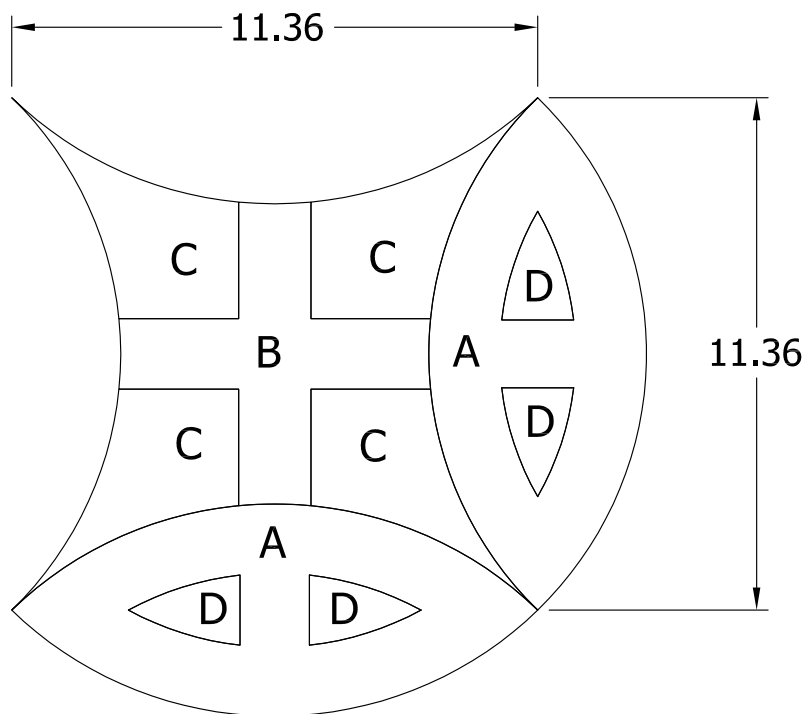

Unit A _____

Unit B _____

Unit C _____

Unit D _____

All designs are made to order and are not returnable. Please chose your colors carefully. Stone and wood materials have a myriad of characteristics. Variation in color and shade are inherent characteristics in these natural materials. Before setting, please verify colors and shade.

Made to measure dimensions are extremely important to ensure that your design fits perfectly into your space. Please take the proper care and steps when providing BKD your dimensions.

.90 s/f per template

- My made to measure dimensions are _____
- they are attached to this sheet with the layout of the room.

Clients Signature

Date

By signing this form I understand that this is a custom design and is not returnable. All materials are subject to have range and variation. I also understand that I am responsible for the made to measure dimensions and when I sign this agreement I am responsible for full payment of this design.



Quoted price _____

barbie kennedy

Date _____

DESIGNS

Whyte Pattern

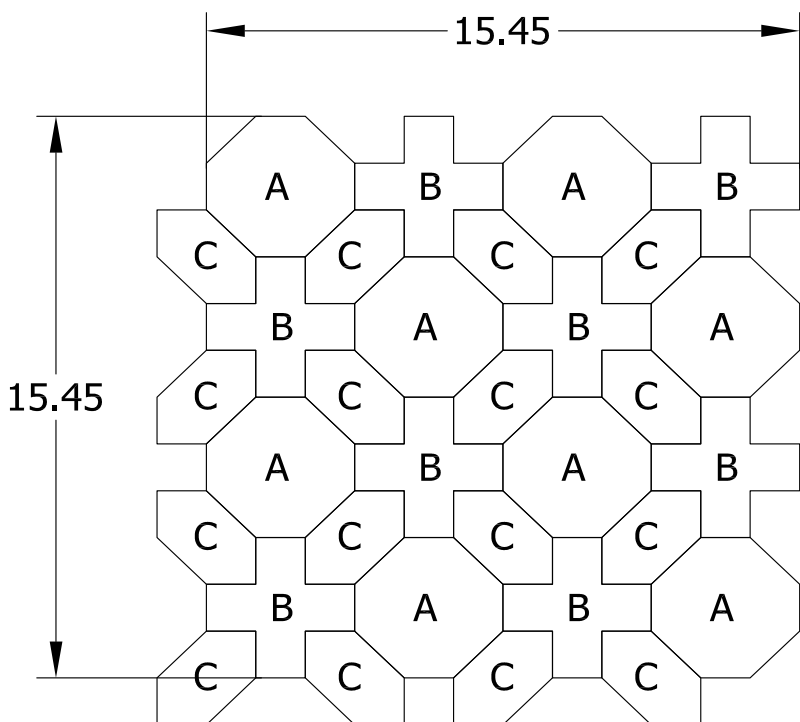

Unit A _____

Unit B _____

Unit C _____

All designs are made to order and are not returnable. Please chose your colors carefully. Stone and wood materials have a myriad of characteristics. Variation in color and shade are inherent characteristics in these natural materials. Before setting, please verify colors and shade.

Made to measure dimensions are extremely important to ensure that your design fits perfectly into your space. Please take the proper care and steps when providing BKD your dimensions.

1.66 s/f per template

- My made to measure dimensions are _____
they are attached to this sheet with the layout of the room.

Clients Signature

Date

By signing this form I understand that this is a custom design and is not returnable. All materials are subject to have range and variation. I also understand that I am responsible for the made to measure dimensions and when I sign this agreement I am responsible for full payment of this design.