



barbie kennedy

DESIGNS

CLASSIC TOOTH

SMALL

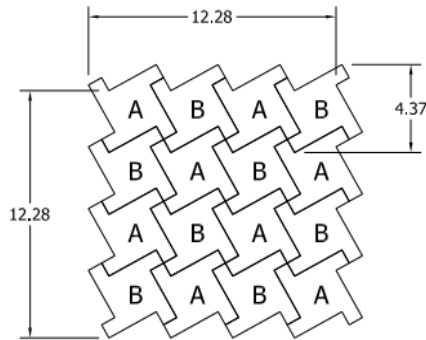

1 unit = 1.05 sq. ft.

UNIT A=
UNIT B=

PRICE
MADE TO MEASURE

MEDIUM

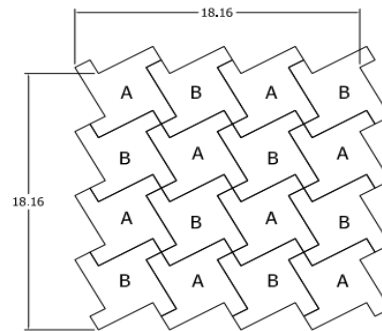

1 unit = 2.29 sq. ft.

UNIT A=
UNIT B=

PRICE
MADE TO MEASURE

LARGE

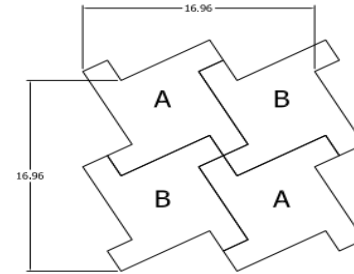

1 unit = 2.00 sq. ft.

UNIT A=
UNIT B=

PRICE
MADE TO MEASURE

BKD RECOMMENDS MADE TO MEASURE FOR WOOD, MIRROR, GLASS AND METAL COMBONATIONS. EPOXY SETTING MATERIALS SHOULD BE USED FOR ALL WOOD AND MIRROR APPLICATIONS. SEE INSTALL INSTRUCTIONS ON OUR WEBSITE. REAL BRASS WILL REQUIRE MAINTENANCE.



barbie kennedy

DESIGNS

CONCENTRIC FLOW

SMALL

Concentric Flow
Small Format



1 unit = 1.46 sq. ft.

UNIT A=
UNIT B=
UNIT C=

PRICE
MADE TO MEASURE

MEDIUM

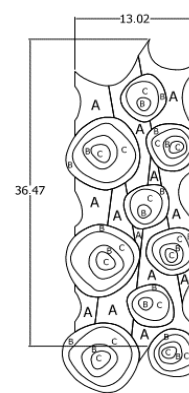

1 unit = 3.30sq. ft.

UNIT A=
UNIT B=
UNIT C=

PRICE
MADE TO MEASURE

LARGE



1 unit = 5.86 sq. ft.

UNIT A=
UNIT B=
UNIT C=

PRICE
MADE TO MEASURE

BKD RECOMMENDS MADE TO MEASURE FOR WOOD, MIRROR, GLASS AND METAL COMBONATIONS. EPOXY SETTING MATERIALS SHOULD BE USED FOR ALL WOOD AND MIRROR APPLICATIONS. SEE INSTALL INSTRUCTIONS ON OUR WEBSITE.
REAL BRASS WILL REQUIRE MAINTENANCE.



barbie kennedy

DESIGNS

CUBIC

SMALL

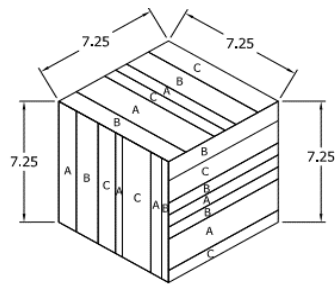

.95 s/f per template

UNIT A=
UNIT B=
UNIT C=

PRICE
MADE TO MEASURE

MEDIUM

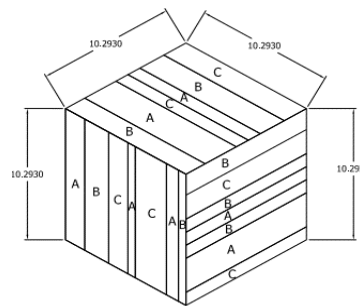

1 unit = 1.91 sq. ft.

UNIT A=
UNIT B=
UNIT C=

PRICE
MADE TO MEASURE

LARGE

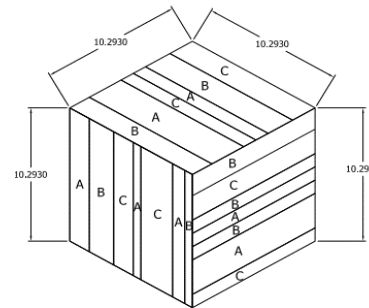

1 unit = 1.91 sq. ft.

UNIT A=
UNIT B=
UNIT C=

PRICE
MADE TO MEASURE

BKD RECOMMENDS MADE TO MEASURE FOR WOOD, MIRROR, GLASS AND METAL COMBONATIONS. EPOXY SETTING MATERIALS SHOULD BE USED FOR ALL WOOD AND MIRROR APPLICATIONS. SEE INSTALL INSTRUCTIONS ON OUR WEBSITE. REAL BRASS WILL REQUIRE MAINTENANCE.



barbie kennedy

DESIGNS

FEATHERS

SMALL

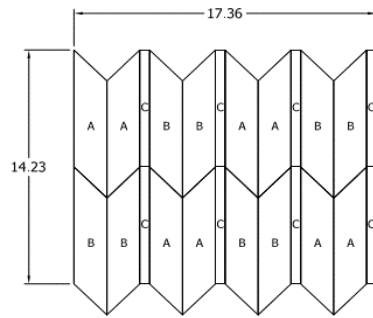

1.72 s/f per templates

UNIT A=
UNIT B=
UNIT C=

PRICE
MADE TO MEASURE

MEDIUM

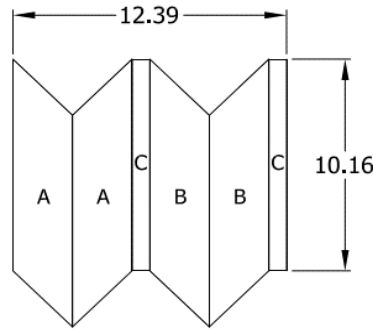

1 unit = .87 sq. ft.

UNIT A=
UNIT B=
UNIT C=

PRICE
MADE TO MEASURE

LARGE

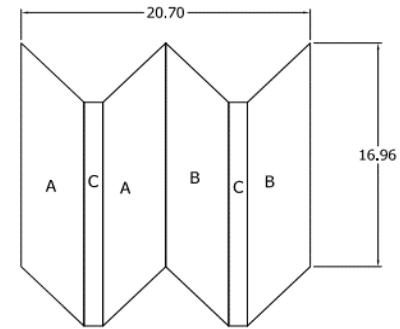

1 unit = 2.93 sq. ft.

UNIT A=
UNIT B=
UNIT C=

PRICE
MADE TO MEASURE

BKD RECOMMENDS MADE TO MEASURE FOR WOOD, MIRROR, GLASS AND METAL COMBONATIONS. EPOXY SETTING MATERIALS SHOULD BE USED FOR ALL WOOD AND MIRROR APPLICATIONS. SEE INSTALL INSTRUCTIONS ON OUR WEBSITE. REAL BRASS WILL REQUIRE MAINTENANCE.



barbie kennedy

DESIGNS

HEXING

SMALL

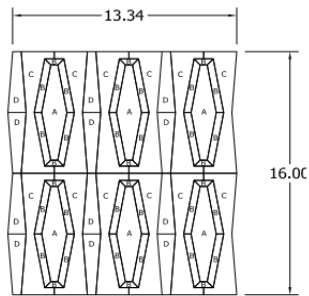

1.48 s/f per template

UNIT A=
UNIT B=
UNIT C=
UNIT D=

PRICE
MADE TO MEASURE

MEDIUM

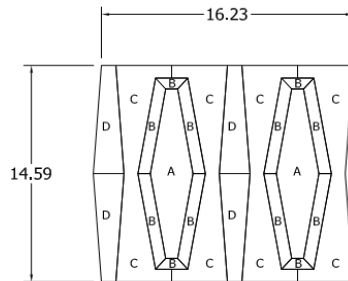

1 unit = 1.64 sq. ft.

UNIT A=
UNIT B=
UNIT C=
UNIT D=

PRICE
MADE TO MEASURE

LARGE

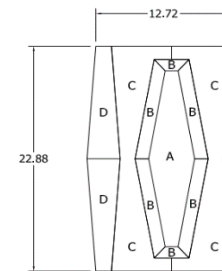

1 unit = 2.02 sq. ft.

UNIT A=
UNIT B=
UNIT C=
UNIT D=

PRICE
MADE TO MEASURE

BKD RECOMMENDS MADE TO MEASURE FOR WOOD AND METAL COMBONATIONS. EPOXY SETTING MATERIALS SHOULD BE USED FOR ALL WOOD APPLICATIONS. SEE INSTALL INSTRUCTIONS ON OUR WEBSITE.
REAL BRASS WILL REQUIRE MAINTENANCE.



barbie kennedy

DESIGNS

LINA WRAP

SMALL

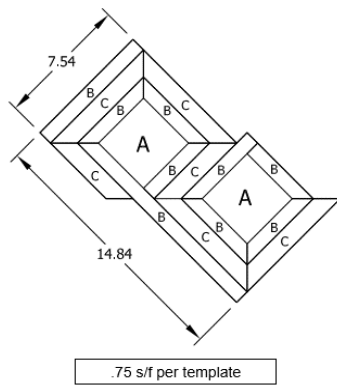

UNIT A=
UNIT B=
UNIT C=

PRICE
MADE TO MEASURE

MEDIUM

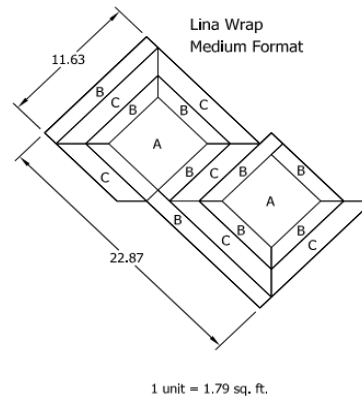

UNIT A=
UNIT B=
UNIT C=

PRICE
MADE TO MEASURE

LARGE

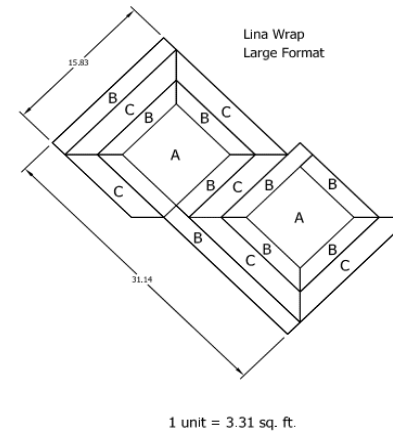

UNIT A=
UNIT B=
UNIT C=

PRICE
MADE TO MEASURE

BKD RECOMMENDS MADE TO MEASURE FOR WOOD, MIRROR, GLASS AND METAL COMBONATIONS. EPOXY SETTING MATERIALS SHOULD BE USED FOR ALL WOOD AND MIRROR APPLICATIONS. SEE INSTALL INSTRUCTIONS ON OUR WEBSITE. REAL BRASS WILL REQUIRE MAINTENANCE.



barbie kennedy

DESIGNS

MODERN OVERLAY

SMALL

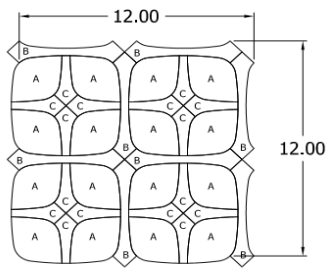

1 unit = 1.00 sq. ft.

UNIT A=
UNIT B=
UNIT C=

PRICE
MADE TO MEASURE

MEDIUM

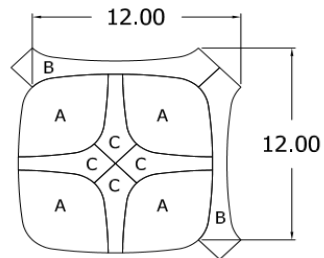

1 unit = 1.00 sq. ft.

UNIT A=
UNIT B=
UNIT C=

PRICE
MADE TO MEASURE

LARGE

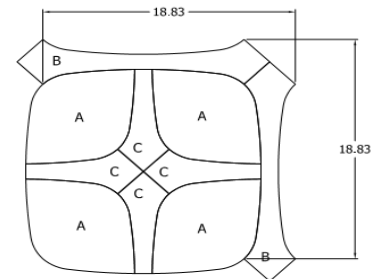

1 unit = 2.46 sq. ft.

UNIT A=
UNIT B=
UNIT C=

PRICE
MADE TO MEASURE

BKD RECOMMENDS MADE TO MEASURE FOR WOOD, MIRROR, GLASS AND METAL COMBONATIONS. EPOXY SETTING MATERIALS SHOULD BE USED FOR ALL WOOD AND MIRROR APPLICATIONS. SEE INSTALL INSTRUCTIONS ON OUR WEBSITE.
REAL BRASS WILL REQUIRE MAINTENANCE.



barbie kennedy

DESIGNS

PERMA LINK

SMALL

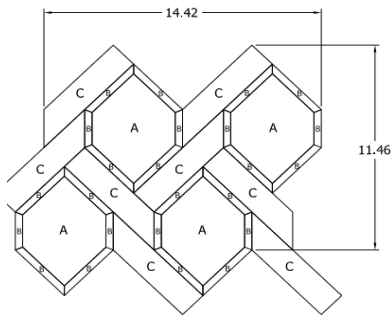

UNIT A=
UNIT B=
UNIT C=

PRICE
MADE TO MEASURE



MEDIUM

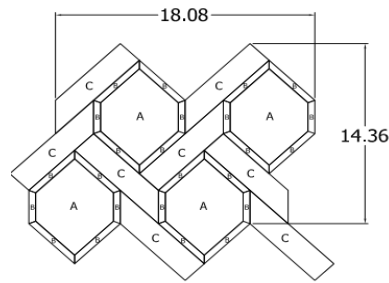

1 unit = 1.80 sq. ft.

UNIT A=
UNIT B=
UNIT C=

PRICE
MADE TO MEASURE

LARGE

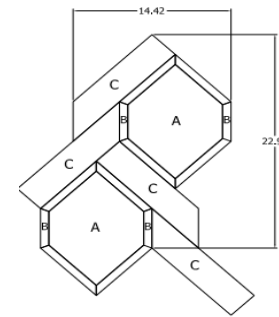

2.29 s/f per template

UNIT A=
UNIT B=
UNIT C=

PRICE
MADE TO MEASURE

BKD RECOMMENDS MADE TO MEASURE FOR WOOD, MIRROR, GLASS AND METAL COMBONATIONS. EPOXY SETTING MATERIALS SHOULD BE USED FOR ALL WOOD AND MIRROR APPLICATIONS. SEE INSTALL INSTRUCTIONS ON OUR WEBSITE. REAL BRASS WILL REQUIRE MAINTENANCE.



barbie kennedy

DESIGNS

SMALL

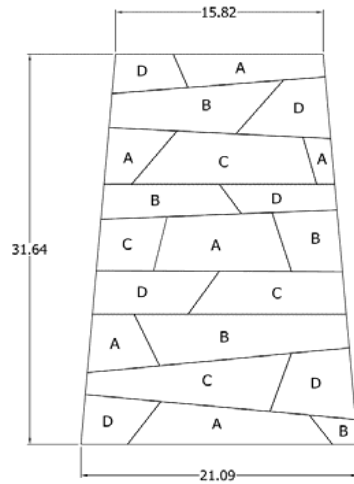

1 unit = 4.06 sq. ft.

UNIT A=
 UNIT B=
 UNIT C=
 UNIT D=

PRICE
 MADE TO MEASURE

WEDGE

LARGE

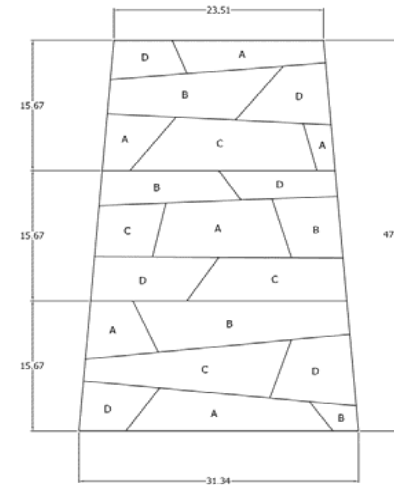

1 unit=8.95 sq. ft.

UNIT A=
 UNIT B=
 UNIT C=
 UNIT D=

PRICE
 MADE TO MEASURE

BKD RECOMMENDS MADE TO MEASURE FOR WOOD, MIRROR, GLASS AND METAL COMBONATIONS. EPOXY SETTING MATERIALS SHOULD BE USED FOR ALL WOOD AND MIRROR APPLICATIONS. SEE INSTALL INSTRUCTIONS ON OUR WEBSITE. REAL BRASS WILL REQUIRE MAINTENANCE.



barbie kennedy

DESIGNS

WIND AND WAVE

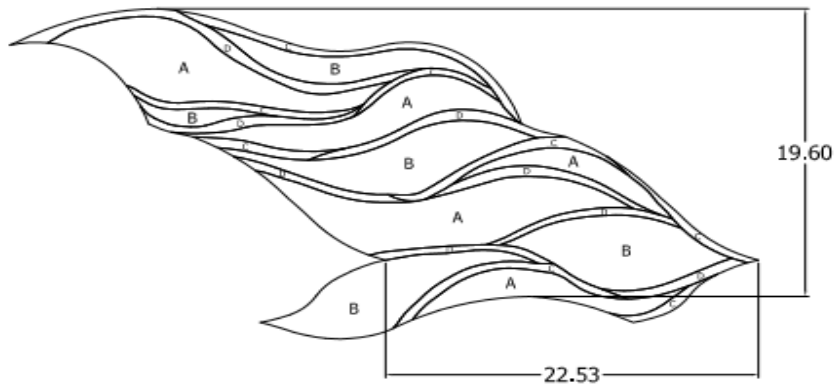

3.066 s/f per template

UNIT A=
UNIT B=
UNIT C=
UNIT D=

PRICE
MADE TO MEASURE

BKD RECOMMENDS MADE TO MEASURE FOR WOOD, MIRROR, GLASS AND METAL COMBONATIONS. EPOXY SETTING MATERIALS SHOULD BE USED FOR ALL WOOD AND MIRROR APPLICATIONS. SEE INSTALL INSTRUCTIONS ON OUR WEBSITE. REAL BRASS WILL REQUIRE MAINTENANCE.